

UC-1000 Host Communication Specifications
(Except North America)
Version 0.0.7

REVISION HISTORY

No.	Date of revision	Description/Time
0.0.4	2017/02/08	Initial Version
0.0.5	2017/04/14	<ul style="list-style-type: none"> • The notation of specific gravity [s.g] is changed to [S.G]. • Table 7-1 Error code list is added.
0.0.5	2017/04/14	<ul style="list-style-type: none"> • Figure 5-2 Connection method 2 is deleted. • The I/O connection circuit is changed (Figure 5-1 Connection method).
0.0.5	2017/05/10	<ul style="list-style-type: none"> • [PadErr] is added in the field of BLD (Table 6-14, Table 6-15)
0.0.5	2017/10/05	<ul style="list-style-type: none"> • The maximum length of transmit data is changed (6.1.2.1 Text format). • The shielded RS-232C cable is specified (5.1.1 Connectors). • The urine color rank code is changed to space padding (Table 6-11)
0.0.6	2017/11/27	<ul style="list-style-type: none"> • Typos are corrected (Table 6-13, Table 6-14). • A transmission protocol “TRANSPAENT1” (for Ver.00-04) is deleted.
0.0.7	2018/01/12	<ul style="list-style-type: none"> • The notation of a space is changed from “□” to “□”. • All text expressions are reviewed.

Contents

1. Scope.....	4
2. Overview.....	4
3. System configuration.....	4
4. Terminology.....	5
5. Hardware specifications.....	6
5.1. Serial communication (RS-232C)	6
5.1.1. Connectors.....	6
5.1.1. I/O circuit.....	7
6. Software specifications.....	7
6.1. Format	7
6.1.1. Serial communication specifications.....	8
6.1.1.1. Transfer methods and parameters	8
6.1.1.2. Check character (BCC/SUM/SUM2/NONE)	10
6.1.2. Codes used.....	10
6.1.2.1. Text format	11
6.1.2.2. Communication protocol.....	11
6.1.3. Analysis result data.....	15
6.1.4. Data format.....	18
6.1.4.1. Overview.....	18
6.1.4.2. Analysis result data	18
6.1.4.3. Analysis result data record of one sample (Analyzer→host).....	18
6.1.5. Examples of communication.....	30
6.1.5.1. Serial communication (HANDSHAKE)	30
6.1.5.2. Serial communication (TRANSPARENT 2).....	31
7. Error codes.....	32
8. Appendix.....	33
8.1. Analysis result output specifications	33
8.2. Flow chart	34

1. Scope

This document is intended to apply to serial communication between the semi-automated urine chemistry analyzer UC-1000 and a host computer.

2. Overview

This document describes the specifications of communication between the semi-automated urine chemistry analyzer UC-1000 and a host computer. This document mainly describes the following items:

- System configuration
- Hardware specifications
- Software specifications

By communicating with the host computer, the semi-automated urine chemistry analyzer UC-1000 can perform the following:

- Outputting qualitative analysis results

3. System configuration

The available system configuration is shown below.

RS-232C is used for communication between UC-1000 and the host computer.

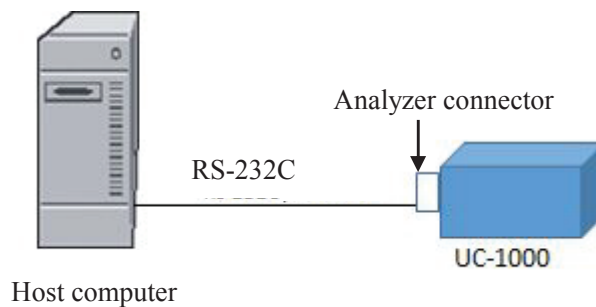

Figure 3-1 Serial communication between UC-1000 and host

4. Terminology

The definition of terms used in this document is as follows:

Table 4-1 Definition of terms

Numeral	Signifies single-byte characters from "0" (30h) to "9" (39h) in ISO/IEC 646 (ACSII) codes. Double-byte characters are not counted as numerals.
Single-byte character	Signifies characters from 00h to 7Fh (7 bit codes) in ISO/IEC 646 (ACSII) codes excluding control codes (00h to 1Fh) and DEL (7Fh).
Double-byte character	Signifies double-byte characters such as hiragana, katakana, and kanji. Each double-byte character uses a space of two single-byte characters.
Qualitative analysis	Inspection to check presence or absence of protein, sugar, and blood in urine by dipping test strips into urine.
UC-1000	Semi-automated urine chemistry analyzer

5. Hardware specifications

UC-1000 supports serial communication.

This chapter describes the hardware specifications of the UC-1000.

5.1. Serial communication (RS-232C)

5.1.1. Connectors

RS-232C cross cable (shielded)

Analyzer-side connector 9-pin D-sub (male)

Cable-side connector 9-pin D-sub (female)

The signal lines and pin arrangement are as follows.

Table 5-1 Signal cable (RS-232C)

Pin No.	Signal name	Signal direction
1		
2	Received data (RxD)	IN
3	Transmit data (TxD)	OUT
4	Data terminal ready (DTR)	OUT
5	Signal ground (SG)	
6	Data set ready (DSR)	IN
7	Request to send (RTS)	OUT
8	Clear to send (CTS)	IN
9		

RTS and DTR always transmit no signal, and DSR signal is ignored.

5.1.1. I/O circuit

There are two options for the I/O circuit as shown below.

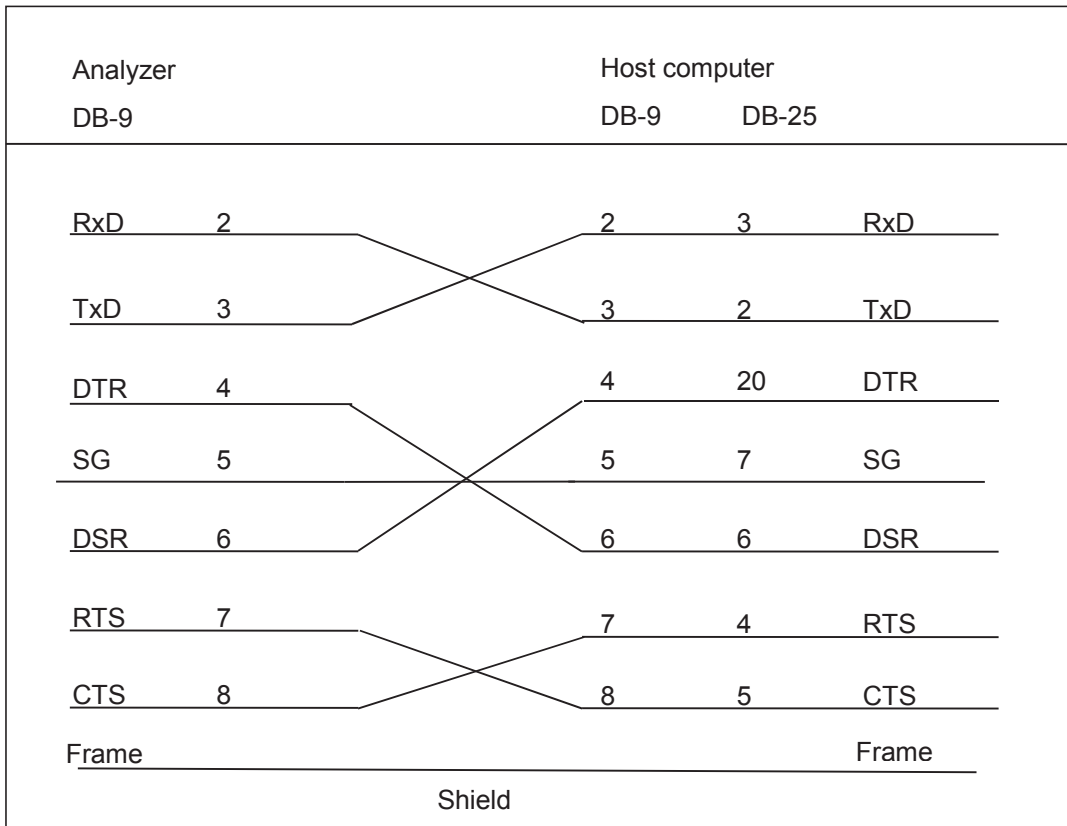

Figure 5-1 Connection method

6. Software specifications

The UC-1000 communicates analysis information with the host computer by using the format below.

- UC-1000 format

The features available in UC-1000 format are as follows:

Table 6-1 Features available in UC-1000 format

Format	Connection	Outputting sample results
UC-1000 format	Serial	See 6.1.4.2.

6.1. Format

The UC-1000 format supports serial communication.

The following sections describe the specifications of serial communication and detailed specifications of data format.

6.1.1. Serial communication specifications

6.1.1.1. Transfer methods and parameters

The table below lists the supported transfer methods and parameters. Parameters can be set on the instrument. See "Figure 6-1 Communication settings dialog" for the setting dialog of the instrument.

Table 6-2 Transfer methods and parameters

Description	Supported object (<u>Underline</u> : Default)
Transfer method	RS-232C
Synchronization method	Start-stop synchronous communication
Communication method	Half-duplex
Codes used	ASCII
Protocol	TRANSPARENT 2, <u>HANDSHAKE</u>
Baud rate	600, 1200, 2400, <u>9600</u> , 19200
Data bit	7 bits, <u>8 bits</u>
Stop bit	<u>1 bit</u> , 2 bit
Parity bit	<u>None</u> , Even, Odd
Data check	BCC, SUM, SUM2, <u>NONE</u>
Timeout A	No response timeout (<u>Default: 5000 msec</u>) (Enabled in HANDSHAKE) Duration between sending of last data and new data reception
Timeout B	Receive timeout (<u>Default: 5000 msec</u>) Duration between receiving first byte and last byte
Retry	Number of times to retry sending data at communication error (<u>Default: 3 times</u>)
Timeout I	Waiting time for sending of text (<u>Default: 1000 msec</u>) (Enabled in TRANSPARENT 2) Duration from last sending of data



Figure 6-1 Communication settings dialog

6.1.1.2. Check character (BCC/SUM/SUM2/NONE)

The check character is calculated according to the "Check" setting as follows.

- In the case of BCC mode, the check character (1 byte) is calculated by XOR of all characters of analysis results and ETX.
- In the case of SUM mode, the check character (1 byte) is calculated by addition of all characters of analysis results and ETX.
- In the case of SUM2 mode, the check character (2 bytes) is calculated by addition of all characters of analysis results and ETX.

* Algorithm of SUM2

Initialized to zero by receiving STX, the check character (2 bytes) is first calculated by addition of characters from the character next to STX to ETX.

The modulo 256 of the addition result is then converted to hexadecimal digits in ASCII code, and the high digit (CSH) and the low digit (CSL) are output in this order.

|STX| Data |ETX|CSH|CSL|

Example) Calculation results 0010 0100 ⇒ |STX| Data |ETX|2|4|

2 4

Calculation results 1101 1111 ⇒ |STX| Data |ETX|D|F|

D F

6.1.2. Codes used

The table below lists the codes used.

Table 6-3 Codes used

Code	Hexadecimal number	Description
STX	02H	Start of text (frame)
ETX	03H	End of text (frame)
CSH	Variable	Checksum, High-order digit
CSL	See 6.1.2.1.	Checksum, Low-order digit
CR	0DH	Carriage return
LF	0AH	Line feed
ACK	06H	Acknowledgement
NAK	15H	Negative Acknowledgement
EOT	04H	End of Transmission

6.1.2.1. Text format

Table 6-4 Text format (TRANSPARENT 2, HANDSHAKE)

STX	Communication (transmission) data (Up to 518 bytes)	ETX	CSH	CSL
-----	---	-----	-----	-----

The text format depends on communication protocols. (For details on the communication protocols, see 6.1.2.2.)

The maximum length of a frame is 522 bytes (including STX, ETX, and checksum. See 6.1.1.2).

6.1.2.2. Communication protocol

① TRANSPARENT 2 (delimiter ••• STX+ETX)

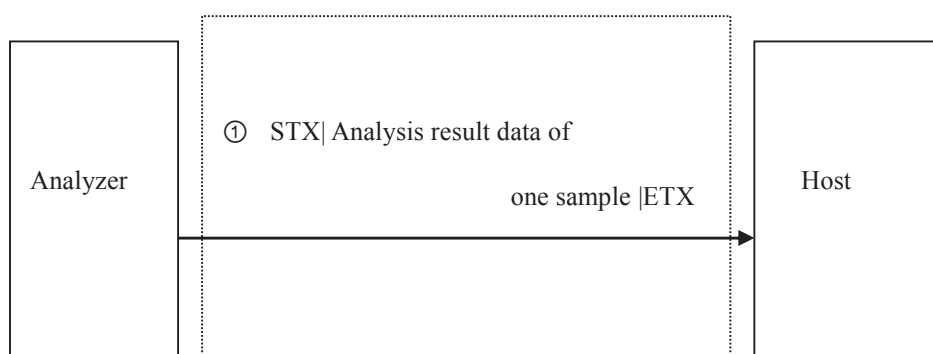

In TRANSPARENT 2 mode, the following settings ("TIME OUT I" and "TIME OUT O") are available on the UC-1000 setting screen.

Table 6-5 TRANSPARENT 2 settings

TIME OUT I	
Setting name	[TIME OUT I]
Explanation	Duration from last sending of data
Setting screen	[MENU] – [Settings] – [Online Settings]
Default setting	1000 [msec]
Setting range	0 to 9999

② HANDSHAKE

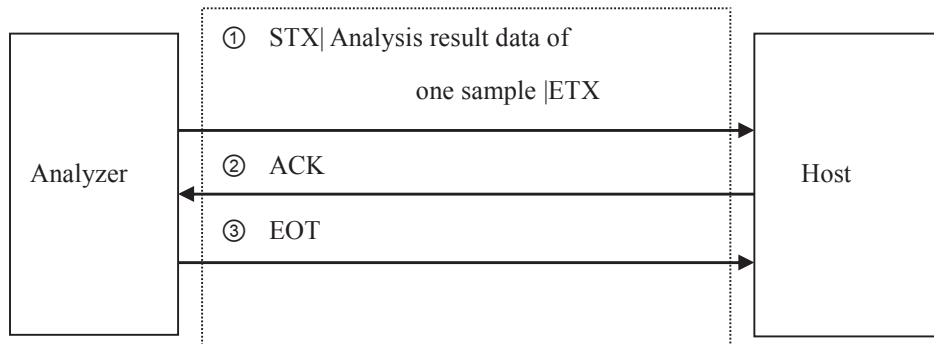

In HANDSHAKE 1 mode, the following settings ("TIME OUT A," "TIME OUT B," and "RETRY") are available on the UC-1000 setting screen.

Table 6-6 HANDSHAKE settings

TIME OUT A	
Setting name	[TIME OUT A]
Explanation	Duration between sending of last data and new data reception
Setting screen	[MENU] – [Settings] – [Online Settings]
Default setting	5000 [msec]
Setting range	0 to 9999

TIME OUT B	
Setting name	[TIME OUT B]
Explanation	Duration between receiving first byte and last byte
Setting screen	[MENU] – [Settings] – [Online Settings]
Default setting	5000 [msec]
Setting range	0 to 9999

RETRY	
Setting name	[RETRY]
Explanation	Number of times to retry sending data at communication error
Setting screen	[MENU] – [Settings] – [Online Settings]
Default setting	3 [times]
Setting range	0 to 99

Transfer phase (HANDSHAKE)

< Start of frame to End of frame>

After sending all frames, the analyzer sends <EOT> to the host computer.

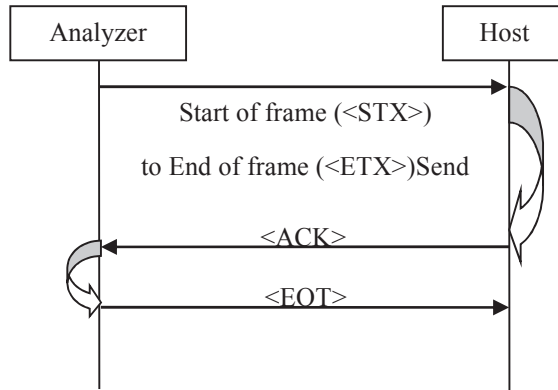

<Reception of NAK>

- If the analyzer receives <NAK> after sending a frame, it resends the frame after timeout.
- If the analyzer does not receive <ACK> after sending the same frame for the number of retry times (see Table 6-2 Transfer methods and parameters), it generates an error after sending <EOT>. (*)

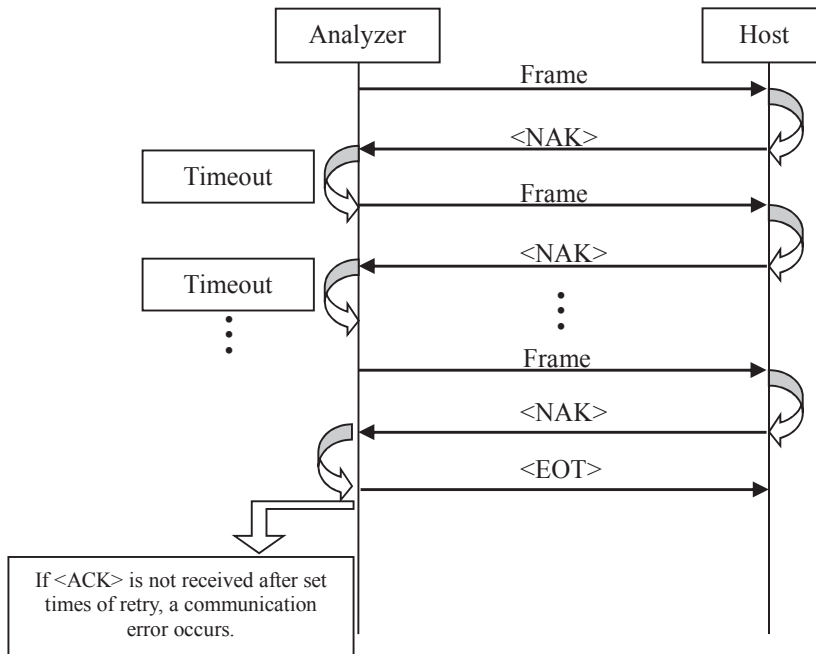

* Note: This communication error occurs to avoid an endless software loop.

When a communication error occurs during outputting of analysis result data, the analyzer stops outputting the data.

<No response>

- If the analyzer receives no response for the time set in [TIME OUT A] (see Table 6-2 Transfer methods and parameters) after sending a frame, it generates an error after sending <EOT>. (*)

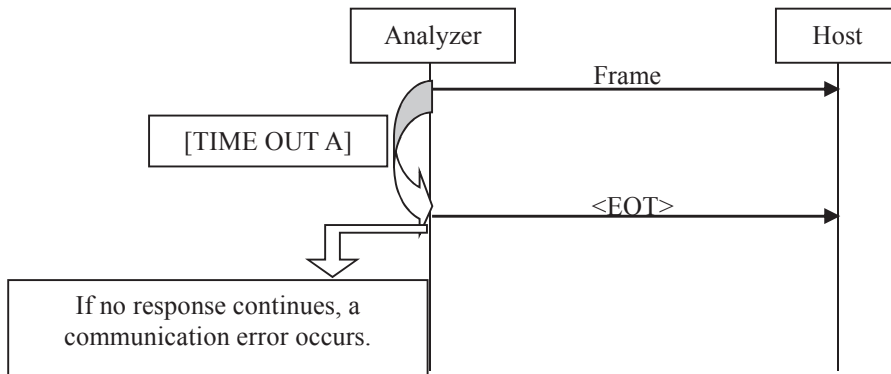

* Note: This error is issued to detect disconnection of lines (including the unplugging of cables).

When a communication error occurs during outputting of analysis result data, the analyzer stops outputting the data.

CAUTION:

① Cautions for TRANSPARENT

The sent data is always assumed to be received properly by the host and will not be resent.

② Cautions for HANDSHAKE

1. If the analyzer receives EOT instead of ACK (or NAK), it aborts the current communication process.
2. If the analyzer receives an incorrect character other than ACK, NAK, and EOT, it sends EOT and aborts the communication.

The host computer performs the same processes as those in items 1 and 2 above.

3. If the analyzer receives NAK or timeout of no response from the host computer, it resends the data as many times as specified in [RETRY] (See Table 6-2 Transfer methods and parameters).

If the resend times is over the no response timeout (Timeout A), the analyzer sends EOT and aborts the communication.

In the case of sending analysis result data, however, the analyzer retries sending the data until the power is turned off.

This means that all analysis result data after that which is not received by the host will be sent to the host at the point of error recovery, unless the instrument power is turned off.

③ Cautions for analysis result data (Analyzer→Host)

1. The analyzer does not send analysis result data when [ORDER ERROR] is set to [SKIP], since no analysis is performed when the order data is abnormal.

If any abend occurs during sending of analysis result data in HANDSHAKE mode, the analyzer discards the data currently being sent.

The analyzer then proceeds to the next process if the error has occurred during real-time sending, or discards the sending of all sample data specified after the error occurs and completes the process if the error has occurred during batch sending.

6.1.4. Data format

6.1.4.1. Overview

Data sent and received consist of records.

Each record consists of multiple fields. The content of each record is defined by record types.

The number of fields in a record is fixed for each record type.

6.1.4.2. Analysis result data

When the analyzer sends analysis result to the host, it sends the record below.

Analysis result data record of one sample

* For details, see “6.1.4.3 Analysis result data record of one sample (Analyzer→Host)”.

6.1.4.3. Analysis result data record of one sample (Analyzer→host)

Analysis result data record of one sample consists of 157 fields.

Table 6-11 Analysis result data record (Analyzer→Host)

No.	Field	Explanation/Example	Notes
1	Barcode ID	Example: "12345678901234" Sample barcode: • When not using barcode, space (20H) padding of 14 bytes	14 bytes
2	Delimiter	Fixed character: ","	1 byte
3	Rack No.	Space padding (20H)	4 bytes
4	Delimiter	Fixed character: ","	1 byte
5	Tube position	Example: "01" When analysis series is set to "C" "Low" is set for control level: "01" "High" is set for control level: "03" When analysis series is set to "N" or "#": Space padding (20H)	2 bytes
6	Delimiter	Fixed character: ","	1 byte
7	Analysis series	"N": No. series (Normal analysis) "#": # series (Emergent analysis) "C": C series (Control analysis)	1 byte
8	Analysis number (sequential number)	"00000000" to "99999999" (Initial value: "00000001")	8 bytes
9	Delimiter	Fixed character: ","	1 byte
10	Error codes	"0000": No error Other than "0000": Codes according to Error code list	4 bytes
11	Delimiter	Fixed character: ","	1 byte
12	Test strip name	Depends on the test strip type. UC-9A: "␣Strip␣9A" UC-10S: "␣Strip␣10S" UC-12S: "␣Strip␣12S" Strip type is not certain: "␣Strip␣??"	10 bytes
13	Delimiter	Fixed character: ","	1 byte
14	Date of analysis	Fixed to [YYYY/MM/DD] format (YYYY: year, MM: month, DD: day)	10 bytes
15	Delimiter	Fixed character: ","	1 byte

16	Time of analysis	Fixed to "HH:MM:SS" format Example: 9:05:30AM "09:05:30"	8 bytes
17	Delimiter	Fixed character: ","	1 byte
18	Analysis state of URO	Signifies whether or not to perform analysis. "0": Analyzed "1": Not analyzed In the case of "1," the fields of "Comment Mark," "Qualitative value," "Concentration value," "Reflectivity(R%(1))," "Reflectivity(R%(2))," and "Reflectivity(R%(3))" are filled with spaces (20H).	1 byte
19	Comment mark	Assay flag Space(20H): No flag "*": Positive "?": Test strip shows abnormal coloration (Weak) "!": Test strip shows abnormal coloration (Strong)	1 byte
20	Qualitative value	URO (Urobilinogen) See "Table 6-12 List of analysis parameter values (Common)". Left-aligned and padded with spaces (20H)	6 bytes
21	Concentration value	URO (Urobilinogen) See "Table 6-12 List of analysis parameter values (Common)". Left-aligned and padded with spaces (20H)	6 bytes
22	Reflectivity(R%(1))*1	URO (Urobilinogen) First reflectivity (R%(1) to one decimal place) Left-aligned and padded with spaces (20H)	5 bytes
23	Space	Fixed character: " " *2	1 byte
24	Reflectivity(R%(2))*1	URO (Urobilinogen) Second reflectivity (R%(2) to one decimal place) Left-aligned and padded with spaces (20H)	5 bytes
25	Space	Fixed character: " " *2	1 byte
26	Reflectivity(R%(3))*1	URO (Urobilinogen) Third reflectivity (R%(3) to one decimal place) Left-aligned and padded with spaces (20H)	5 bytes
27	Delimiter	Fixed character: ","	1 byte
28	Analysis state of BLD	See "No.18".	1 byte
29	Comment mark	See "No.19".	1 byte
30	Qualitative value	BLD (Blood) See "Table 6-12 List of analysis parameter values (Common)". Left-aligned and padded with spaces (20H)	6 bytes
31	Concentration value	BLD (Blood) See "Table 6-12 List of analysis parameter values (Common)". Left-aligned and padded with spaces (20H)	6 bytes
32	Reflectivity(R%(1))*1	BLD (Blood) First reflectivity (R%(1) to one decimal place) Left-aligned and padded with spaces (20H)	5 bytes
33	Space	Fixed character: " " *2	1 byte
34	Reflectivity(R%(2))*1	BLD (Blood) Second reflectivity (R%(2) to one decimal place) Left-aligned and padded with spaces (20H)	5 bytes

35	Space	Fixed character: " " *2	1 byte
36	Reflectivity(R%(3))*1	BLD (Blood) Third reflectivity (R%(3) to one decimal place) Left-aligned and padded with spaces (20H)	5 bytes
37	Delimiter	Fixed character: ","	1 byte
38	Analysis state of BIL	See "No.18".	1 byte
39	Comment mark	See "No.19".	1 byte
40	Qualitative value	BIL (Bilirubin) See "Table 6-12 List of analysis parameter values (Common)". Left-aligned and padded with spaces (20H)	6 bytes
41	Concentration value	BIL (Bilirubin) See "Table 6-12 List of analysis parameter values (Common)". Left-aligned and padded with spaces (20H)	6 bytes
42	Reflectivity(R%(1))*1	BIL (Bilirubin) First reflectivity (R%(1) to one decimal place) Left-aligned and padded with spaces (20H)	5 bytes
43	Space	Fixed character: " " *2	1 byte
44	Reflectivity(R%(2))*1	BIL (Bilirubin) Second reflectivity (R%(2) to one decimal place) Left-aligned and padded with spaces (20H)	5 bytes
45	Space	Fixed character: " " *2	1 byte
46	Reflectivity(R%(3))*1	BIL (Bilirubin) Third reflectivity (R%(3) to one decimal place) Left-aligned and padded with spaces (20H)	5 bytes
47	Delimiter	Fixed character: ","	1 byte
48	Analysis state of KET	See "No.18".	1 byte
49	Comment mark	See "No.19".	1 byte
50	Qualitative value	KET (Ketones) See "Table 6-12 List of analysis parameter values (Common)". Left-aligned and padded with spaces (20H)	6 bytes
51	Concentration value	KET (Ketones) See "Table 6-12 List of analysis parameter values (Common)". Left-aligned and padded with spaces (20H)	6 bytes
52	Reflectivity(R%(1))*1	KET (Ketones) First reflectivity (R%(1) to one decimal place) Left-aligned and padded with spaces (20H)	5 bytes
53	Space	Fixed character: " " *2	1 byte
54	Reflectivity(R%(2))*1	KET (Ketones) Second reflectivity (R%(2) to one decimal place) Left-aligned and padded with spaces (20H)	5 bytes
55	Space	Fixed character: " " *2	1 byte
56	Reflectivity(R%(3))*1	KET (Ketones) Third reflectivity (R%(3) to one decimal place) Left-aligned and padded with spaces (20H)	5 bytes
57	Delimiter	Fixed character: ","	1 byte
58	Analysis state of GLU	See "No.18".	1 byte
59	Comment mark	See "No.19".	1 byte
60	Qualitative value	GLU (Glucose)	6 bytes

		See "Table 6-12 List of analysis parameter values (Common)". Left-aligned and padded with spaces (20H)	
61	Concentration value	GLU (Glucose) See "Table 6-12 List of analysis parameter values (Common)". Left-aligned and padded with spaces (20H)	6 bytes
62	Reflectivity(R%(1))*1	GLU (Glucose) First reflectivity (R%(1) to one decimal place) Left-aligned and padded with spaces (20H)	5 bytes
63	Space	Fixed character: " " *2	1 byte
64	Reflectivity(R%(2))*1	GLU (Glucose) Second reflectivity (R%(2) to one decimal place) Left-aligned and padded with spaces (20H)	5 bytes
65	Space	Fixed character: " " *2	1 byte
66	Reflectivity(R%(3))*1	GLU (Glucose) Third reflectivity (R%(3) to one decimal place) Left-aligned and padded with spaces (20H)	5 bytes
67	Delimiter	Fixed character: ","	1 byte
68	Analysis state of PRO	See "No.18".	1 byte
69	Comment mark	See "No.19".	1 byte
70	Qualitative value	PRO (Protein) See "Table 6-12 List of analysis parameter values (Common)". Left-aligned and padded with spaces (20H)	6 bytes
71	Concentration value	PRO (Protein) See "Table 6-12 List of analysis parameter values (Common)". Left-aligned and padded with spaces (20H)	6 bytes
72	Reflectivity(R%(1))*1	PRO (Protein) First reflectivity (R%(1) to one decimal place) Left-aligned and padded with spaces (20H)	5 bytes
73	Space	Fixed character: " " *2	1 byte
74	Reflectivity(R%(2))*1	PRO (Protein) Second reflectivity (R%(2) to one decimal place) Left-aligned and padded with spaces (20H)	5 bytes
75	Space	Fixed character: " " *2	1 byte
76	Reflectivity(R%(3))*1	PRO (Protein) Third reflectivity (R%(3) to one decimal place) Left-aligned and padded with spaces (20H)	5 bytes
77	Delimiter	Fixed character: ","	1 byte
78	Analysis state of pH	See "No.18".	1 byte
79	Comment mark	See "No.19".	1 byte
80	Qualitative value	pH See "Table 6-12 List of analysis parameter values (Common)". Left-aligned and padded with spaces (20H)	6 bytes
81	Concentration value	pH See "Table 6-12 List of analysis parameter values (Common)". Left-aligned and padded with spaces (20H)	6 bytes
82	Reflectivity(R%(1))*1	pH First reflectivity (R%(1) to one decimal place) Left-aligned and padded with spaces (20H)	5 bytes

83	Space	Fixed character: "␣" *2	1 byte
84	Reflectivity(R%(2))*1	pH Second reflectivity (R%(2) to one decimal place) Left-aligned and padded with spaces (20H)	5 bytes
85	Space	Fixed character: "␣" *2	1 byte
86	Reflectivity(R%(3))*1	pH Third reflectivity (R%(3) to one decimal place) Left-aligned and padded with spaces (20H)	5 bytes
87	Delimiter	Fixed character: ","	1 byte
88	Analysis state of NIT	See "No.18".	1 byte
89	Comment mark	See "No.19".	1 byte
90	Qualitative value	NIT (Nitrite) See "Table 6-12 List of analysis parameter values (Common)". Left-aligned and padded with spaces (20H)	6 bytes
91	Concentration value	NIT (Nitrite) See "Table 6-12 List of analysis parameter values (Common)". Left-aligned and padded with spaces (20H)	6 bytes
92	Reflectivity(R%(1))*1	NIT (Nitrite) First reflectivity (R%(1) to one decimal place) Left-aligned and padded with spaces (20H)	5 bytes
93	Space	Fixed character: "␣" *2	1 byte
94	Reflectivity(R%(2))*1	NIT (Nitrite) Second reflectivity (R%(2) to one decimal place) Left-aligned and padded with spaces (20H)	5 bytes
95	Space	Fixed character: "␣" *2	1 byte
96	Reflectivity(R%(3))*1	NIT (Nitrite) Third reflectivity (R%(3) to one decimal place) Left-aligned and padded with spaces (20H)	5 bytes
97	Delimiter	Fixed character: ","	1 byte
98	Analysis state of LEU	See "No.18".	1 byte
99	Comment mark	See "No.19".	1 byte
100	Qualitative value	LEU (Leukocyte) See "Table 6-12 List of analysis parameter values (Common)". Left-aligned and padded with spaces (20H)	6 bytes
101	Concentration value	LEU (Leukocyte) See "Table 6-12 List of analysis parameter values (Common)". Left-aligned and padded with spaces (20H)	6 bytes
102	Reflectivity(R%(1))*1	LEU (Leukocyte) First reflectivity (R%(1) to one decimal place) Left-aligned and padded with spaces (20H)	5 bytes
103	Space	Fixed character: "␣" *2	1 byte
104	Reflectivity(R%(2))*1	LEU (Leukocyte) Second reflectivity (R%(2) to one decimal place) Left-aligned and padded with spaces (20H)	5 bytes
105	Space	Fixed character: "␣" *2	
106	Reflectivity(R%(3))*1	LEU (Leukocyte) Third reflectivity (R%(3) to one decimal place) Left-aligned and padded with spaces (20H)	
107	Delimiter	Fixed character: ","	1 byte
108	Analysis state	See "No.18".	1 byte

	of S.G (strip)		
109	Comment mark	See "No.19".	1 byte
110	Qualitative value	S.G (Specific Gravity) See "Table 6-12 List of analysis parameter values (Common)". Left-aligned and padded with spaces (20H)	6 bytes
111	Concentration value	S.G (Specific Gravity) See "Table 6-12 List of analysis parameter values (Common)". Left-aligned and padded with spaces (20H)	6 bytes
112	Reflectivity(R%(1))*1	S.G (Specific Gravity) First reflectivity (R%(1) to one decimal place) Left-aligned and padded with spaces (20H)	5 bytes
113	Space	Fixed character: " " *2	1 byte
114	Reflectivity(R%(2))*1	S.G (Specific Gravity) Second reflectivity (R%(2) to one decimal place) Left-aligned and padded with spaces (20H)	5 bytes
115	Space	Fixed character: " " *2	1 byte
116	Reflectivity(R%(3))*1	S.G (Specific Gravity) Third reflectivity (R%(3) to one decimal place) Left-aligned and padded with spaces (20H)	5 bytes
117	Delimiter	Fixed character: ","	1 byte
118	Analysis state of CRE	See "No.18".	1 byte
119	Comment mark	See "No.19".	1 byte
120	Qualitative value	CRE (Creatinine) See "Table 6-12 List of analysis parameter values (Common)". Left-aligned and padded with spaces (20H)	6 bytes
121	Concentration value	CRE (Creatinine) See "Table 6-12 List of analysis parameter values (Common)". Left-aligned and padded with spaces (20H)	6 bytes
122	Reflectivity(R%(1))*1	CRE (Creatinine) First reflectivity (R%(1) to one decimal place) Left-aligned and padded with spaces (20H)	5 bytes
123	Space	Fixed character: " " *2	1 byte
124	Reflectivity(R%(2))*1	CRE (Creatinine) Second reflectivity (R%(2) to one decimal place) Left-aligned and padded with spaces (20H)	5 bytes
125	Space	Fixed character: " " *2	1 byte
126	Reflectivity(R%(3))*1	CRE (Creatinine) Third reflectivity (R%(3) to one decimal place) Left-aligned and padded with spaces (20H)	5 bytes
127	Delimiter	Fixed character: ","	1 byte
128	Analysis state of ALB	See "No.18".	1 byte
129	Comment mark	See "No.19".	1 byte
130	Qualitative value	ALB (Albumin) See "Table 6-12 List of analysis parameter values (Common)". Left-aligned and padded with spaces (20H)	6 bytes
131	Concentration value	ALB (Albumin) See "Table 6-12 List of analysis parameter values	6 bytes

		(Common)". Left-aligned and padded with spaces (20H)	
132	Reflectivity(R%(1))*1	ALB (Albumin) First reflectivity (R%(1) to one decimal place) Left-aligned and padded with spaces (20H)	5 bytes
133	Space	Fixed character: " " *2	1 byte
134	Reflectivity(R%(2))*1	ALB (Albumin) Second reflectivity (R%(2) to one decimal place) Left-aligned and padded with spaces (20H)	5 bytes
135	Space	Fixed character: " " *2	1 byte
136	Reflectivity(R%(3))*1	ALB (Albumin) Third reflectivity (R%(3) to one decimal place) Left-aligned and padded with spaces (20H)	5 bytes
137	Delimiter	Fixed character: ","	1 byte
138	Analysis state of P/C	See "No.18".	1 byte
139	Comment mark	See "No.19".	1 byte
140	Qualitative value	P/C (Protein/Creatinine ratio) See "Table 6-12 List of analysis parameter values (Common)". Left-aligned and padded with spaces (20H)	6 bytes
141	Concentration value	P/C (Protein/Creatinine ratio) See "Table 6-12 List of analysis parameter values (Common)". Left-aligned and padded with spaces (20H)	6 bytes
142	Delimiter	Fixed character: ","	1 byte
143	Analysis state of A/C	See "No.18".	1 byte
144	Comment mark	See "No.19".	1 byte
145	Qualitative value	A/C (Albumin/Creatinine ratio) See "Table 6-12 List of analysis parameter values (Common)". Left-aligned and padded with spaces (20H)	6 bytes
146	Concentration value	A/C (Albumin/Creatinine ratio) See "Table 6-12 List of analysis parameter values (Common)". Left-aligned and padded with spaces (20H)	6 bytes
147	Delimiter	Fixed character: ","	1 byte
148	Analysis state	See "No.18".	1 byte
149	Comment mark	See "No.19".	1 byte
150	Qualitative value	S.G (Specific gravity refractometer) See "Table 6-12 List of analysis parameter values (Common)". Left-aligned and padded with spaces (20H)	6 bytes
151	Concentration value	S.G (Specific gravity refractometer) See "Table 6-12 List of analysis parameter values (Common)". Left-aligned and padded with spaces (20H)	6 bytes
152	Delimiter	Fixed character: ","	1 byte
153	Analysis state of urine color	See "No.18".	1 byte
154	Comment mark	See "No.19".	1 byte
155	Urine color rank code *1	Space (20H) padding of 4 bytes	4 bytes

156	Urine color	Light yellow: "L␣YELLOW␣␣01" Straw : "STRAW␣␣␣␣␣02" Yellow : "YELLOW␣␣␣␣␣03" Amber : "AMBER␣␣␣␣␣04" Red : "RED␣␣␣␣␣␣␣05" Dark brown: "DK␣BROWN␣␣06" Others : "OTHER␣␣␣␣␣␣00" *2	12 bytes
157	Turbidity	"2+" "1+" "␣-"*2	2 bytes

*1: Only output when the service setting is as follows.

- [TEST MODE SETTINGS]-[SHIPPING]: OTHER
- [TEST MODE SETTINGS]-[REFLEX PRINT]: ON

For the flow chart of reflectivity (R%(1), R%(2), and R%(3)), see 8.2 Analysis result output flow.

*2: "␣" signifies a space (20H).

Table 6-12 List of analysis parameter values (Common)

Item	Qualitative value (F)	Concentration value (C) [Common]	Unit	Reflectivity (R%(1), R%(2), and R%(3))
URO	normal	(20H)	mg/dL	0.0 to 999.9
	1+	2.0		
	2+	4.0		
	3+	8.0		
	4+	12.0		
BLD (Hemoglobin)	-	(20H)	mg/dL	0.0 to 999.9
	+ -	0.03		
	1+	0.06		
	2+	0.15		
	3+	0.75		
	PadErr	(20H)		
BLD (RBC)	-	(20H)	cells/μL	0.0 to 999.9
	+ -	10		
	1+	20		
	2+	50		
	3+	250		
BIL	-	(20H)	mg/dL	0.0 to 999.9
	1+	0.5		

	2+	1.0		
	3+	2.0		
KET	-	(20H)	mg/dL	0.0 to 999.9
	1+	10		
	2+	30		
	3+	80		
GLU	-	(20H)	mg/dL	0.0 to 999.9
	+-	50		
	1+	100		
	2+	250		
	3+	500		
	4+	2000		
PRO	-	(20H)	mg/dL	0.0 to 999.9
	+-	15		
	1+	30		
	2+	100		
	3+	300		
	4+	1000		
pH	5.0	(20H)		0.0 to 999.9
	5.5			
	6.0			
	6.5			
	7.0			
	7.5			
	8.0			
	8.5			
	9.0			
NIT	-	(20H)		0.0 to 999.9
	+			
LEU	-	(20H)	cells/ μ L	0.0 to 999.9
	1+	25		
	2+	75		
	3+	500		
S.G	1.000 to 1.030	(20H)		0.0 to 999.9
CRE	10	(20H)	mg/dL	0.0 to 999.9
	50			
	100			
	200			

	300			
ALB	10	(20H)	mg/L	0.0 to 999.9
	30			
	80			
	150			
	over			
P/C	dilute	(20H)	g/gCr	/
	normal	(20H)		
	1+	0.15		
	1+	0.30		
	2+	>=0.50		
	ERR	(20H)		
A/C	dilute	(20H)	mg/gCr	/
	normal	(20H)		
	1+	30		
	1+	80		
	1+	150		
	>=1+	>=80		
	>=1+	>=150		
	2+	>=300		
	ERR	(20H)		
S.G (Refractometer)	(20H)	(20H)		/

※ Although BLD (Occult blood) is one item, the analyzer automatically determines whether the result is BLD (Hemoglobin) or BLD (RBC). When storing the results after discernment on the system, assume that the result is BLD (Hemoglobin) if the concentration value includes a decimal point, and assume BLD (RBC) if the value is an integer.

Note that the units are different between BLD (Hemoglobin) and BLD (RBC). Be careful when reporting values with units.

BLD (Hemoglobin): [mg/dL]

BLD (RBC) : [cells/uL]

※ The result output follows the format registered in [Service]-[DECISION DATA].

※ When R%(3) is used for analysis, Reflectivity is set in R%(1), R%(2) and R%(3) fields. When R%(2) is used for analysis, Reflectivity is set in R%(1) and R%(2) fields and the field of R%(3) is filled with spaces (20H). When only R%(1) is used for analysis, Reflectivity is set in R%(1) fields, and the fields of R%(2) and R%(3) are filled with spaces (20H)

※ Analysis result data is output to the host computer in common units regardless of the setting of unit in the UC-1000. When the SI unit is specified on the host computer, use the conversion table (See **Table 6-13** List of analysis parameter values (SI)).

Table 6-13 List of analysis parameter values (SI)

Item	Qualitative value (F)	Concentration value (C) [SI]	Unit	Reflectivity (R%(1), R%(2), and (R%(3))
URO	normal	(20H)	μmol/L	0.0 to 999.9
	1+	34		
	2+	68		
	3+	135		
	4+	202		
BLD (Hemoglobin)	-	(20H)	mg/dL	0.0 to 999.9
	+-	0.03		
	1+	0.06		
	2+	0.15		
	3+	0.75		
	PadErr	(20H)		
BLD (RBC)	-	(20H)	cells/μL	0.0 to 999.9
	+-	10		
	1+	20		
	2+	50		
	3+	250		
BIL	-	(20H)	μmol/L	0.0 to 999.9
	1+	8.6		
	2+	17		
	3+	34		
KET	-	(20H)	mmol/L	0.0 to 999.9
	1+	0.93		
	2+	2.8		
	3+	7.4		
GLU	-	(20H)	mmol/L	0.0 to 999.9
	+-	2.8		
	1+	5.6		
	2+	14		
	3+	28		
	4+	111		
PRO	-	(20H)	g/L	0.0 to 999.9
	+-	0.15		
	1+	0.3		
	2+	1.0		

	3+	3.0		
	4+	10		
pH	5.0	(20H)		0.0 to 999.9
	5.5			
	6.0			
	6.5			
	7.0			
	7.5			
	8.0			
	8.5			
	9.0			
NIT	-	(20H)		0.0 to 999.9
	+			
LEU	-	(20H)	cells/ μ L	0.0 to 999.9
	1+	25		
	2+	75		
	3+	500		
S.G	1.000 to 1.030	(20H)		0.0 to 999.9
CRE	0.1	(20H)	g/L	0.0 to 999.9
	0.5			
	1.0			
	2.0			
	3.0			
ALB	0.01	(20H)	g/L	0.0 to 999.9
	0.03			
	0.08			
	0.15			
	over			
P/C	dilute	(20H)	g/gCr	/
	normal	(20H)		
	1+	0.15		
	1+	0.30		
	2+	≥ 0.50		
	ERR	(20H)		
A/C	dilute	(20H)	mg/gCr	/
	normal	(20H)		
	1+	30		
	1+	80		

	1+	150		
	>=1+	>=80		
	>=1+	>=150		
	2+	>=300		
	ERR	(20H)		
S.G (Refractometer)	(20H)	(20H)		

6.1.5. Examples of communication

6.1.5.1. Serial communication (HANDSHAKE)

Analysis result data record of one sample (Analyzer→Host)

Direction	Communication example
Analyzer -> Host	<STX>20070222000101,0001,01,N00000001,0000, Strip 10S,2015/04/02,14:17:50,0 normal 98.2 91.9 102.0 97.2 95.8 108.6 5.5 172.9 109.9 94.2 1.010 68.0 1 1 1 1 1 0 YELLOW 03-<ETX>
Host ->Analyzer	<ACK>
Analyzer -> Host	<EOT>

6.1.5.2.Serial communication (TRANSPARENT 2)

Analysis result data record of one sample (Analyzer→host)

Direction	Communication example REFLEX PRINT:[ON]
Analyzer -> Host	<STX>20070222000101,0001,01,N00000001,0000,Strip10,2015/04/02,14:17:50,0normal 98.2 0 91.9 0 102.0 0 97.2 0 95.8 0 108.6 0 5.5 172.9 0 109.9 0 94.2 0 1.010 68.0 1 1 1 0 YELLOW 03-<ETX>

7. Error codes

Table 7-1 Error code list

Code	Error contents	Actions
1100	Analysis Timeout	Check if there is an abnormality near the photometry unit.
4020	Lighting is insufficient.	<ul style="list-style-type: none"> • Check if there is an abnormality near the photometry unit. • Remove the test strip holder and check if any test strip has fallen in the vicinity.
5010	Strip is set incorrectly. The width of the strip is incorrect. The length of the strip is incorrect. The end of the strip is not recognized correctly.	<ul style="list-style-type: none"> • Check if test strip other than that specified is used. • Remove the test strip holder and check if any test strip has fallen in the vicinity.
6040	Strip is set in reverse.	Check the orientation of the test strip in the test strip receptacle.
7010	Barcode on the strip is not recognized correctly.	Check if the test strip is correct.
7020	Strip is not recognized correctly.	Check if test strip other than that specified is used.
7030	Strip is not recognized correctly.	<ul style="list-style-type: none"> • Check if test strip other than that specified is used. • Place the test strip so that its front edge touches the back side of the test strip feeder section.
7050	Line mark is not detected.	<ul style="list-style-type: none"> • Check if test strip other than that specified is used. • Place the test strip so that its front edge touches the back side of the test strip feeder section.
8050	Counterfeit error	Check if test strip other than that specified is used.

8. Appendix

8.1. Analysis result output specifications

Test mode

Confirmation mode On Off

Reflex Print On Off

Shipping USA Other

Capture On Off

Unit SI Common

Initialize On Off

LAN On Off

Figure 8-1 Test mode setting screen

	log on	User mode	Service mode		
	SHIPPING				
	USA	①	②		
	Other	①	②		
① User Mode					
Measurement series	Screen	Built-in printer	Host computer	External media(USB)	
No.	(qualitative value, semi-quantitative value)	(qualitative value, semi-quantitative value)	(qualitative value, semi-quantitative value)	(qualitative value, semi-quantitative value)	(qualitative value, semi-quantitative value)
C.	(qualitative value, semi-quantitative value)	(qualitative value, semi-quantitative value)	(qualitative value, semi-quantitative value)	(qualitative value, semi-quantitative value)	(qualitative value, semi-quantitative value)
#	(qualitative value, semi-quantitative value)	(qualitative value, semi-quantitative value)	(qualitative value, semi-quantitative value)	(qualitative value, semi-quantitative value)	(qualitative value, semi-quantitative value)
② Service Mode					
Measurement series	Screen	Built-in printer	Host computer	External media(USB)	
No.	(qualitative value, semi-quantitative value, R%, urine color rank)	(qualitative value, semi-quantitative value)	(qualitative value, semi-quantitative value)	(qualitative value, semi-quantitative value, R%, urine color rank)	(qualitative value, semi-quantitative value, R%, urine color rank)
C.	(qualitative value, semi-quantitative value, R%, urine color rank)	(qualitative value, semi-quantitative value)	(qualitative value, semi-quantitative value)	(qualitative value, semi-quantitative value, R%, urine color rank)	(qualitative value, semi-quantitative value, R%, urine color rank)
#	(qualitative value, semi-quantitative value, R%, urine color rank)	(qualitative value, semi-quantitative value)	(qualitative value, semi-quantitative value)	(qualitative value, semi-quantitative value, R%, urine color rank)	(qualitative value, semi-quantitative value, R%, urine color rank)
③ "REFLEX PRINT" is "ON"					
Measurement series	Screen	Built-in printer	Host computer	External media(USB)	
No.	(qualitative value, semi-quantitative value, R%, urine color rank)	(qualitative value, semi-quantitative value, R%, urine color rank)	(qualitative value, semi-quantitative value, R%, urine color rank)	(qualitative value, semi-quantitative value, R%, urine color rank)	(qualitative value, semi-quantitative value, R%, urine color rank)
C.	(qualitative value, semi-quantitative value, R%, urine color rank)	(qualitative value, semi-quantitative value, R%, urine color rank)	(qualitative value, semi-quantitative value, R%, urine color rank)	(qualitative value, semi-quantitative value, R%, urine color rank)	(qualitative value, semi-quantitative value, R%, urine color rank)
#	(qualitative value, semi-quantitative value, R%, urine color rank)	(qualitative value, semi-quantitative value, R%, urine color rank)	(qualitative value, semi-quantitative value, R%, urine color rank)	(qualitative value, semi-quantitative value, R%, urine color rank)	(qualitative value, semi-quantitative value, R%, urine color rank)

8.2. Flow chart

